

MaxHT Air Heater

FOR SAFETY AND LONG HEATER LIFE,
CAREFULLY READ THIS MANUAL BEFORE USE.



SureHeat

THANK YOU FOR CHOOSING THE MAX HT AIR HEATER

TUTCO MAX HT AIR HEATER

The Max HT provides a compact, efficient heater for heating air or inert gases to 1652°F (900°C). The Max HT comes in various power ratings ranging from 18kW to 36kW. The heater is equipped with two (2) type “K” thermocouples. One thermocouple measures the inlet air temperature (S1) and the other is a dual probe type “K” thermocouple with each probe of the exit thermocouple used to measure exit air temperature. One is typically used for process temperature control and the other to monitor high temperature limit. When powered and controlled with TUTCO SureHeat approved controls (sold separately) you are provided a convenient, cost effective solution for safely controlling the AC power to your Max HT. If operated correctly, the heater will operate continuously for 5000 hours or longer.

SPECIFICATIONS

Maximum Inlet Air Pressure	80 PSI (5.52 BAR)
Maximum Inlet Air Temperature	200°F (93°C)
Maximum Exit Air Temperature	1652°F (900°C)
Minimum Airflow (Recommended)	18 SCFM (510 SLPM)
Exit Air Connection:	1-1/2” FNPT
Inlet Air Connection:	1-1/4” FNPT
Safety Approvals:	UL Recognized, CE
Control/Limit Sensors:	Type “K” isolated, ungrounded, exposed junction TCs: S1 measures inlet temperature Dual Probe Type “K” isolated, ungrounded, exposed junction TC (both used to measure exit temperature)

GENERAL INFORMATION

Environmental Conditions:

Ambient Temperature	32°F to 104°F (0°C to 40°C)
Humidity	0% to 95% R.H.

Ventilation:

Use in a well-ventilated area away from excess dust, dirt, and moisture.

Cleaning:

With unit OFF and unplugged, exterior surfaces may be wiped clean using a dry, lint-free cloth.

Protective Earthing:

Each heater comes with a convenient grounding stud and hardware located at the inlet of the heater for protective means of earthing.

WARNINGS!



TUTCO SureHeat Process Air Heaters contain high watt-density elements and must be controlled carefully to prevent element failure.

IMPORTANT: Be sure to read and understand this operating manual before turning the system ON. Follow all checklists shown in the manual. Failure to do so can cause a heater failure and may void warranty.

ONLY qualified individuals should install and service this heater and related controls.

Do not hesitate to contact TUTCO SureHeat with any questions
Phone: 1-800-258-8290
E-Mail: support@tutcosureheat.com



ELECTRICAL SHOCK HAZARD!

Follow all applicable electrical codes and use proper wiring.



BURN/FIRE/EXPLOSION HAZARD!

For use with Air or Inert Gases Only -

Do not use with or near explosive or reactive gases.



Avoid contact with the surface of the heater especially the air exit-end during or soon after operation. Depending on the installation location customer may need to install protective screen or guard to prevent injury to personnel and comply with OSHA code.

DO NOT USE NEAR VOLATILE OR COMBUSTIBLE MATERIALS.

PRECAUTIONS

1. Use filtered air. Avoid grease, oil, or oil vapors, corrosive or reactive gases which will damage heater.

Note: When using compressed air a pressure reduction valve and an oil & water separation unit should be installed to avoid contaminating the heater and reducing heater life.

2. Operate at safe voltages as shown on the Performance Curves (see page 11). Excess voltage will cause premature failure. (See Proper Temperature Controller Setup on Page 7 for details.)

3. If using a process air temperature thermocouple other than one of the supplied “K” thermocouple probes it is highly recommended that one of the exit thermocouples be used with a temperature limiting device.

4. If using closed-loop control, use a temperature controller with a fast sampling period (<500ms) and minimal overshoot.

HEATER MODEL AND PARTS LIST

Part Number	Maximum Wattage	Maximum Voltage	Maximum Amperage	Suggested wire size for 60°C cable*	Suggested wire size for 90°C cable*	Replacement Elements
F077081	18.0kW	240 – 3Ø 50/60Hz	43.4	8	10	F206707
F077082	18.0kW	380 – 3Ø 50/60Hz	27.4	12	12	F206662
F077083	18.0kW	480 – 3Ø 50/60Hz	21.7	12	12	F206663
F077084	30.0kW	380 – 3Ø 50/60Hz	45.6	8	8	F206664
F077085	36.0kW	480 – 3Ø 50/60Hz	43.4	8	10	F206598

* Follow applicable electrical codes during installation

COMPATIBLE HEATER CONTROLS

Part Number	Part	Compatible Heaters
F078136	Closed-Loop Controls	F077081, F077085
F078135	Closed-Loop Controls	F077083
F078217	Closed-Loop Controls	F077084, F077082

DIMENSIONS/MOUNTING

NOTE: The inlet side of the heater is located where the leads/power feedthrus come out of the housing. Failure to install the heater in its proper orientation can result in heater damage and is not covered under the manufacturer's warranty.

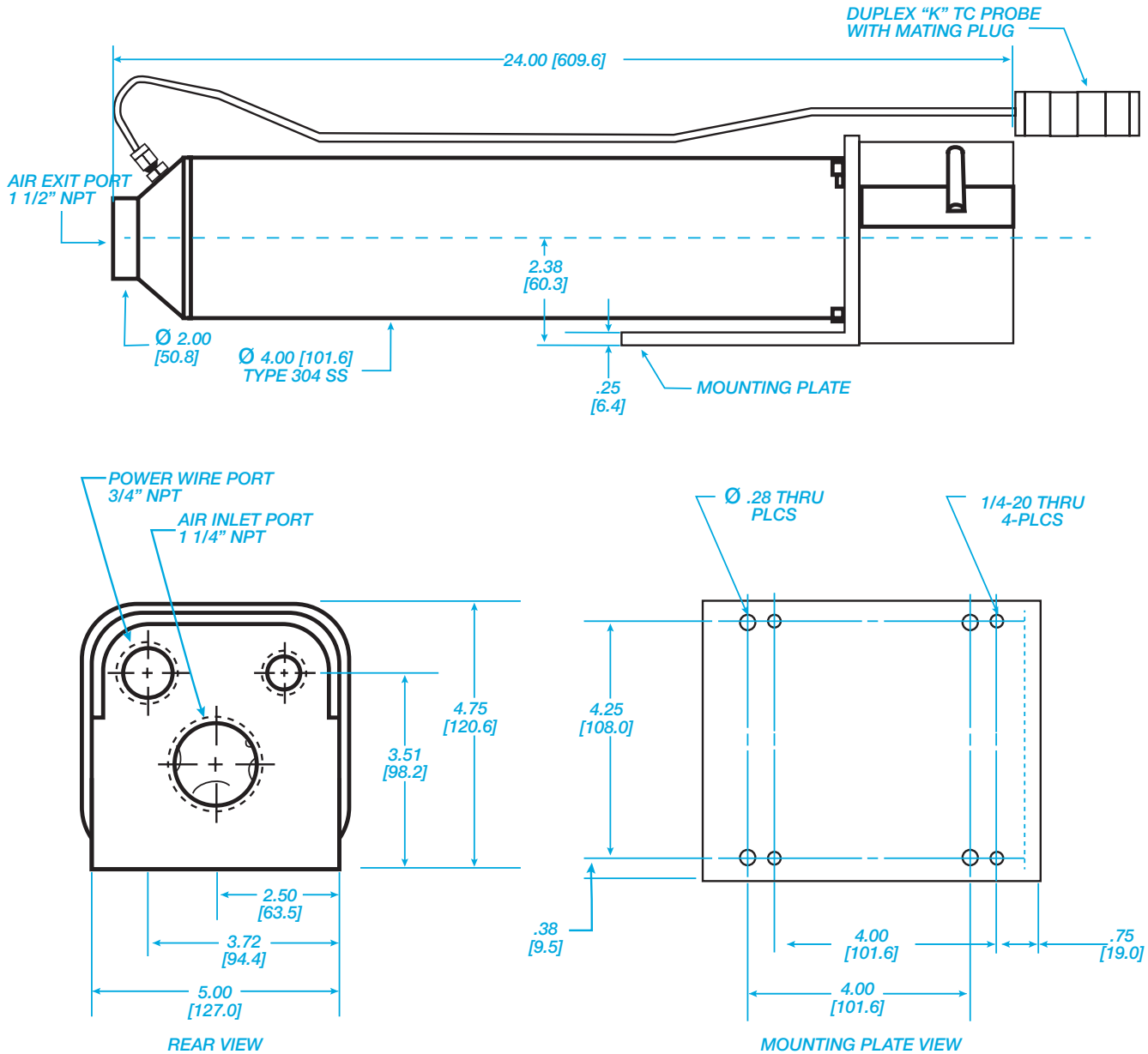



Warning: Avoid Damage to Housing
 3/8" NPT (Sensor): 4 ft-lb
 3/4" NPT (Power): 25 ft-lb
 1-1/4" NPT (Air): 7 ft-lb
 (Excessive force will crack housing and void warranty)

INSTALLATION



WARNING: THE INLET AIR/GAS SIDE OF THE HEATER IS THE PLASTIC HOUSING END WHERE THE POWER TERMINALS AND THERMOCOUPLE TERMINAL BLOCK IS LOCATED. INSTALLING THE HEATER IN THE WRONG ORIENTATION WILL DAMAGE THE HEATER AND CAN CREATE ADDITIONAL HAZARDS AS A RESULT. POWER CONNECTION WIRE SIZES ARE RECOMMENDED IN THE PRODUCT TABLE ABOVE. THESE ARE RECOMMENDATIONS ONLY, AND ALL LOCAL, REGIONAL AND NATIONAL ELECTRICAL CODES SHOULD BE CONSULTED.

1

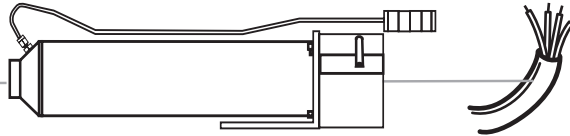

MOUNT AND WIRE HEATER

Mount heater before wiring. Wire according to diagram on Page 9. Follow applicable electrical codes.

2

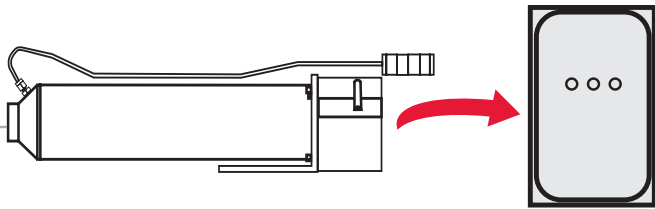

WIRE HEATER TO CONTROL (G, H1, H2, H3) and (S1, S2)

- Suitable POWER CONTROL types:
 1. "Zero-Cross" Solid State Relay (SSR), (Pulsed DC Input) - or -
 2. "Phase-Angle" Fired Silicon Controlled Rectifier (SCR) (4-20mA Input)
- K" THERMOCOUPLE WIRE must be Teflon Coated and Teflon Insulated, note RED is NEGATIVE (-).
- S1 Type "K" Thermocouple Sensor on heater connects to INLET LIMIT controller. TUTCO SureHeat sets INLET TEMP LIMIT to 300°F/150°C.
- S2 Type "K" Thermocouple Sensor on heater connects to EXIT TEMP controller. TUTO SureHeat sets EXIT TEMP ALARM at 1405°F/763°C.
- Set Power Controller to 1652°F (900°C) MAXIMUM to prevent overshooting and element failure.
- The MINIMUM airflow needed to avoid damaging the heater is 18 SCFM (510 SLPM)

HEATER TO CONTROL (H1, H2, H3) POWER WIRES are standard 8 to 12 Gauge, 4-wire (H1, H2, H3) electrical cable.

3

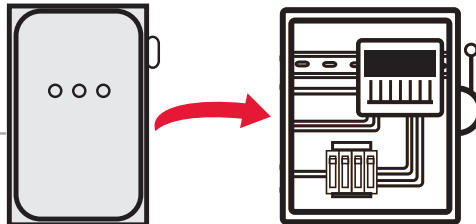

WIRE CONTROL TO MAIN POWER (L1, L2, L3,)

MAIN POWER WIRES are standard AWG #8 to 12 gauge, 4-wire (L1, L2, L3, H1, H2, H3) electrical cable. MAIN POWER WIRE fuses must be sized based on maximum heater current. (see heater ratings to properly size by applicable electrical codes)



PROPER TORQUE VALVES FOR FITTINGS

WARNING: Avoid Damage to Housing
 3/8" NPT (Sensor): 4 ft-lb
 3/4" NPT (Power): 25 ft-lb
 1-1/4" NPT (Air): 7 ft-lb
 (Excessive force will crack housing and void warranty)

TYPICAL WIRING

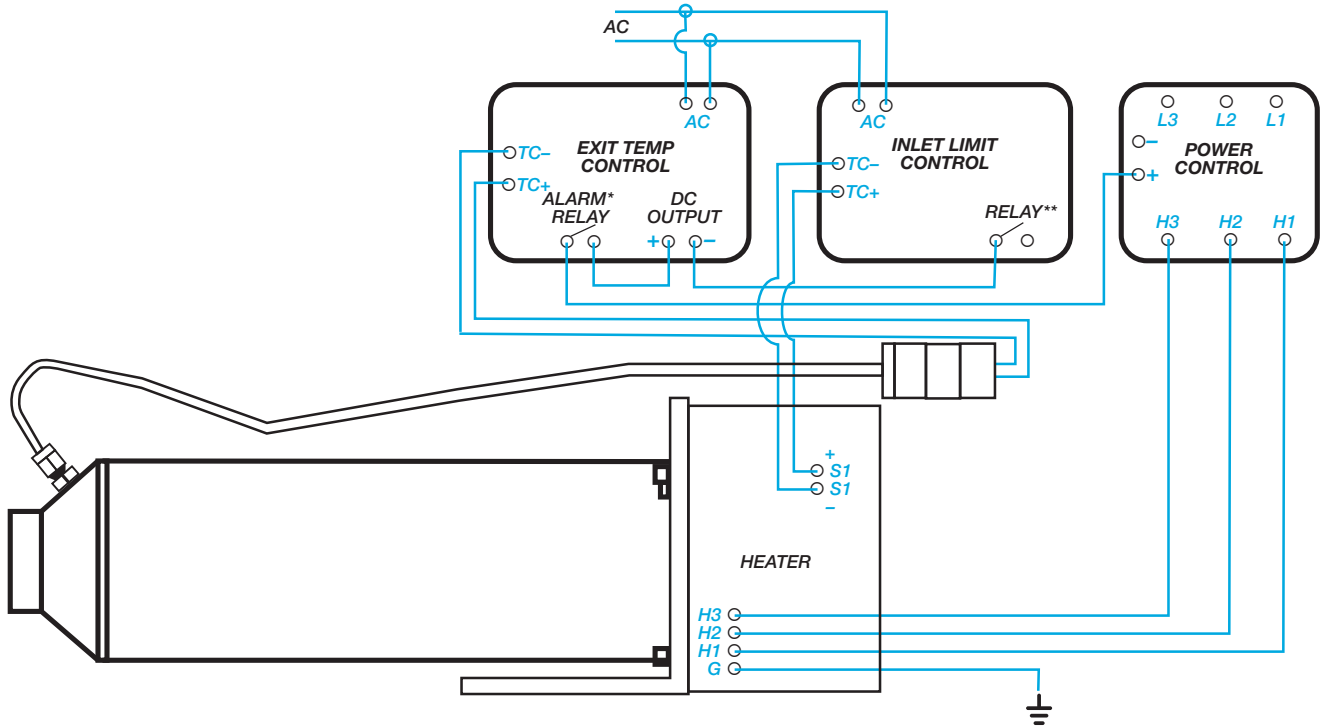

SureHeat® Max HT

* Exit Temp Alarm Relay to open at 905C (1661F)
 **Inlet Limit Relay to open at 150C (300F)
 Other settings may damage heater and void warranty.

OPERATION (with Heater)

START-UP

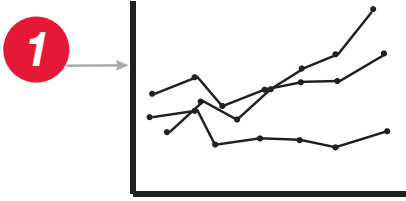

REFERENCE PERFORMANCE CURVES
Beginning on page 11 prior to operating heater.

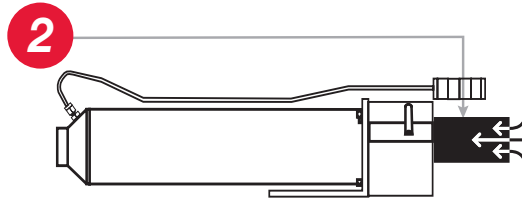

CONNECT AIR SOURCE TO HEATER

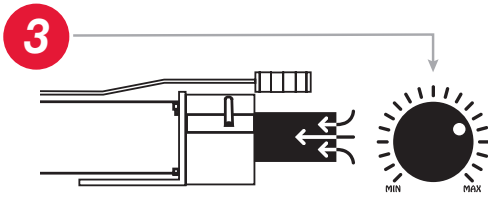

TURN ON AIR
Set pressure or flow to desired operating level.

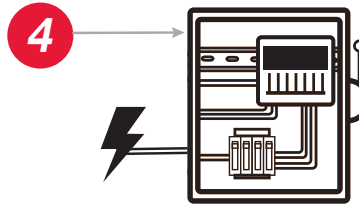

ENERGIZE MAIN POWER LINE
Via disconnect switch or circuit breaker on control cabinet.

5 CONTROL AIRFLOW
During operation, with constant airflow, the exit temperature will vary only a few degrees from set point. Although the heater will not burn out with zero airflow, if the heater is operated in a vertical downward position and an airflow of 18 SCFM or less is run through the heater, the inlet temperature of the heater will exceed 300°F/150°C and the low limit controller will begin to limit power to the heater.

6 CLOSED OR OPEN-LOOP SYSTEM
If using a closed loop system, turn on power to the temperature and power controller, then set the desired temperature on the temperature controller. If using an open loop system, increase power to the heater through the power controller until the desired temperature is attained.

SHUT-DOWN

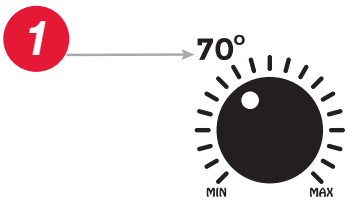

RETURN SET-POINT TEMPERATURE TO AMBIENT OR BELOW

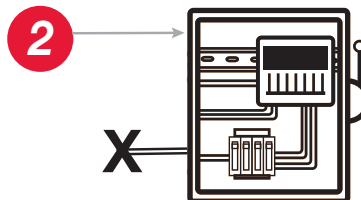

TURN OFF MAIN POWER

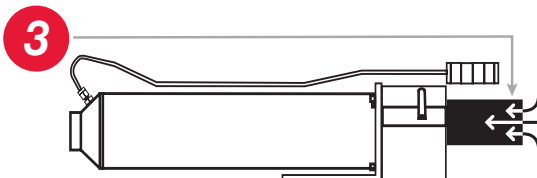

CONTINUE AIR FLOW
Allow air to continue to flow for a minimum of 1 minute or until exit air temperature is 300°F/150°C or less for safety. Continue airflow longer as necessary to prevent burn hazard to personnel.

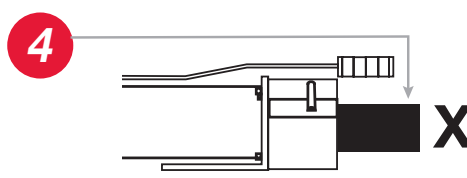

TURN OFF AIR TO SYSTEM

PERFORMANCE CURVES

The attached performance curves show exit air temperatures at different airflows and voltages.

MAX HT MAXIMUM PERFORMANCE CURVE

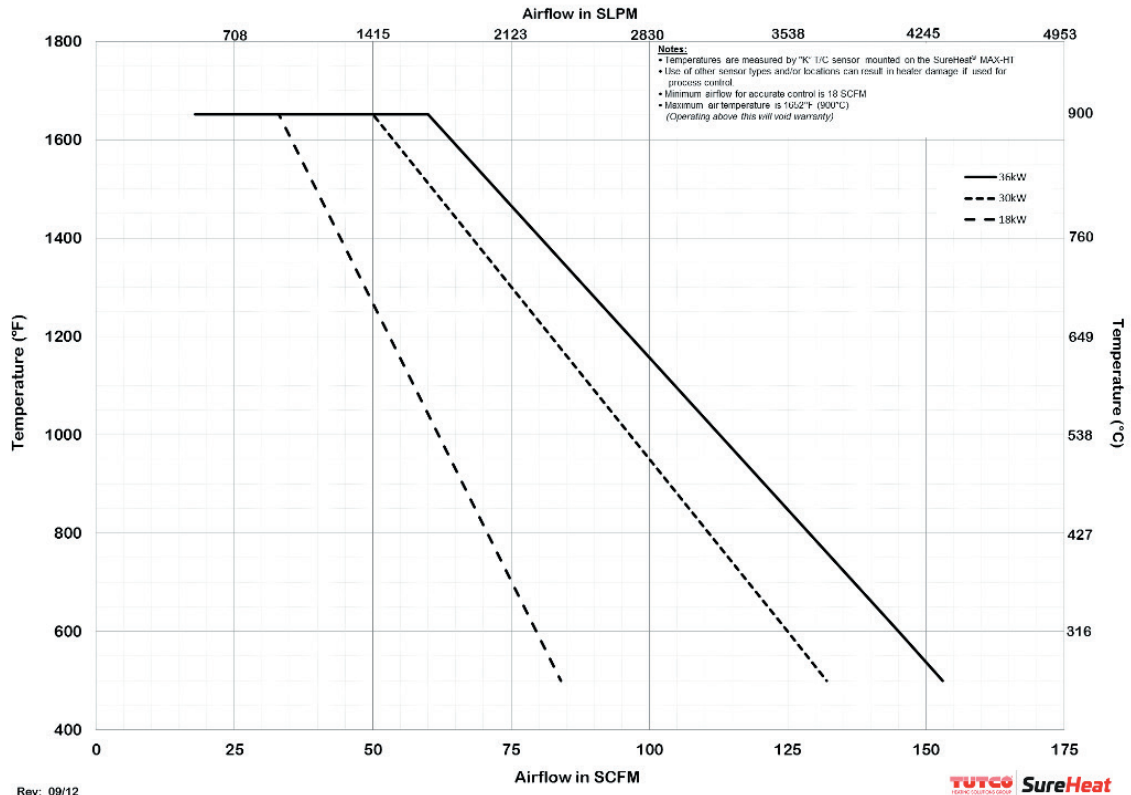

PRESSURE DROP FOR MAX HT OPERATING AT 900° C

Pressure readings (right side of chart) are measured at the inlet of the heater with no exit restrictions.

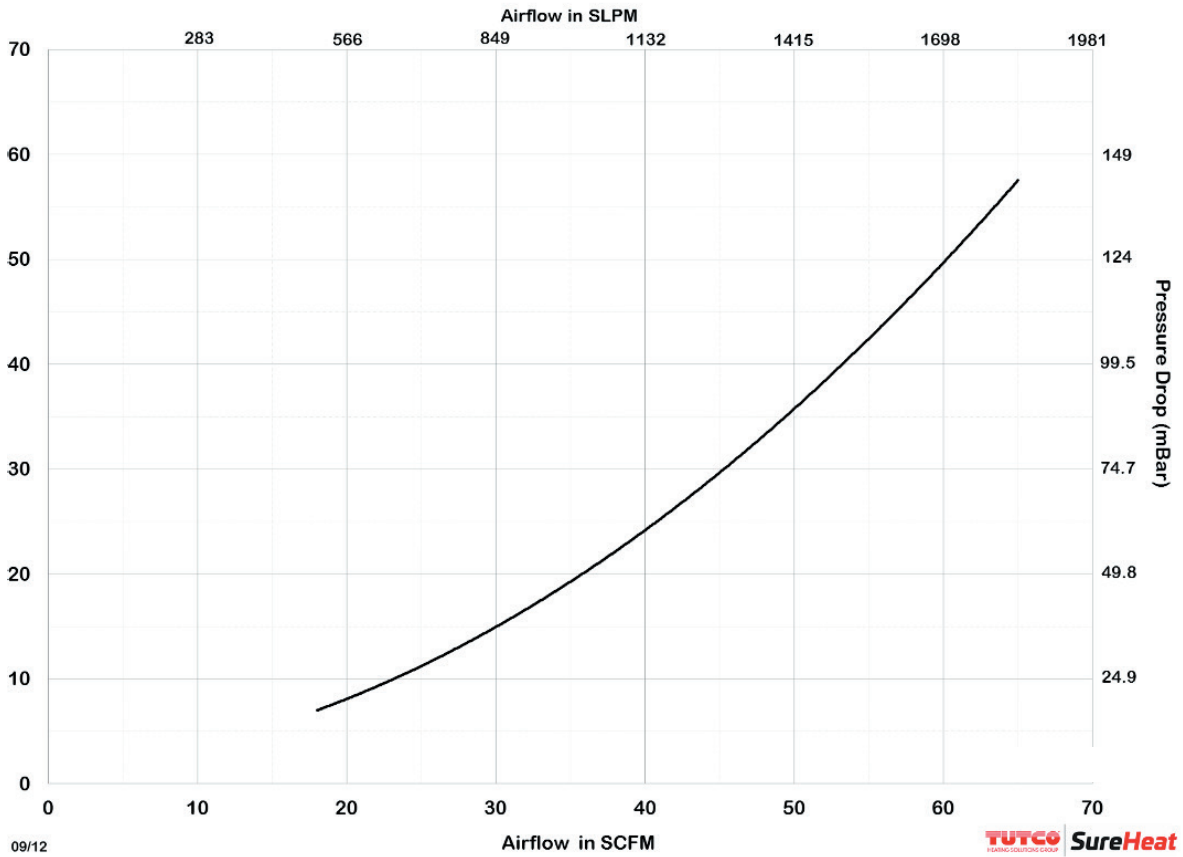

TROUBLESHOOTING AND HEATER REPLACEMENT

- 1.** Note that “TYPICAL” Element Life is APPROXIMATELY 5000 hours. This is based on heater element operating at or below temperatures shown on PERFORMANCE CURVE(S). In addition to normal end of life, elements can fail due to mechanical damage, or problems with the control system.
- 2.** If an element has failed prematurely, it should be inspected by SureHeat to determine the cause of the element failure.
- 3.** When replacing or troubleshooting heaters, turn off power to the system and be sure to follow lock-out/tag-out procedures.
 - a.** For Troubleshooting Heater
 - i.)** Use multi-meter to check continuity between:
 - Power terminals: H1-H2, H2-H3, and H1-H3
 - Thermocouples: Positive (+ yellow) to Negative (- red)
 - ii.)** If there is continuity on all above tests, check system wiring:
 - Crossed thermocouple wires.
 - Reversed thermocouple wire polarity – Note: RED is NEGATIVE (-).
 - Verify inlet air temperature is below set point on INLET TEMPERATURE controller.
 - iii.)** If there is no continuity on any test, then contact your local TUTCO SureHeat representative for assistance.
- 4.** Remove entire heater assembly from system. Internal components are typically not replaceable.
- 5.** Reconnect thermocouples, power and ground wires for new/replacement heater.
- 6.** Attach any covers and operate heater per operating manual.

LIMITED WARRANTY

TUTCO SureHeat warrants that all products to be delivered hereunder will be free from defects in material and workmanship at the time of delivery. TUTCO SureHeat's obligation under this warranty shall be limited to (at its option) repairing, replacing, or granting a credit at the prices invoiced at the time of shipment for any of said products. This warranty shall not apply to any such products which shall have been repaired or altered, except by TUTCO SureHeat, or which shall have been subjected. TUTCO SureHeat shall be liable under this warranty only if (A) TUTCO SureHeat receives notice of the alleged defect within sixty (60) days after the date of shipment; (B) the adjustment procedure hereinafter provided is followed, and (C) such products are, to TUTCO SureHeat's satisfaction, determined to be defective.

THE WARRANTY SET FORTH IN THE PRECEDING PARAGRAPH IS EXCLUSIVE AND IN LIEU OF ALL OTHER WARRANTIES, EXPRESS OR IMPLIED, INCLUDING, WITHOUT LIMITATION, ANY IMPLIED WARRANTY OF FITNESS FOR A PARTICULAR PURPOSE OR OF MERCHANTABILITY.

The information contained in this manual is based on data considered to be true and accurate. Reasonable precautions for accuracy has been taken in the preparation of this manual, however TUTCO SureHeat assumes no responsibility for any omissions or errors, nor assumes any liability for damages that may result from the use of the product in accordance with the information contained in this manual.

Please direct all warranty/repair requests or inquiries to the place of purchase, and provide the following information, in writing:

- (A) Order number under which products were shipped
- (B) Model/Serial Number of product
- (C) Reason for rejection

PRODUCTS CAN NOT BE RETURNED TO TUTCO SUREHEAT WITHOUT AUTHORIZATION.

Replacement, repair, or credit for products found to be defective will be made by the place of purchase. All products found to be not defective will be returned to the Buyer; transportation charges collect or stored at Buyers expense.



Aerospace Automotive 3D Printing Electronics Medicine Packaging Printing Plastics Textiles

Electric Industrial Air Heaters for Demanding High-Temperature Applications

The technical data and specifications supplied in this operating manual are subject to change without prior notice. Contact TUTCO SureHeat for additional assistance.



800-258-8290

support@tutcosureheat.com orders@tutcosureheat.com

22 Industrial Drive Exeter, NH 03833 USA